

USER INSTRUCTION



version
without a display



version
with an LCD display

HUMIDITY AND TEMPERATURE TRANSDUCER AR252



Thank you for choosing our product.

*This instruction is intended to facilitate correct operation,
safe use, and taking full advantage of the device's functionalities.*

Before you start the device, please read and understand this instruction.

In the event of any additional questions, please contact our technical adviser.

CONTENTS

1. SAFETY PRINCIPLES.....	3
2. INSTALLATION GUIDELINES.....	3
3. GENERAL CHARACTERISTICS OF THE TRANSDUCER	3
4. CONTENTS OF THE SET.....	4
5. TECHNICAL DATA.....	4
6. ENCLOSURE DIMENSIONS AND INSTALLATION DATA.....	5
7. DESCRIPTION OF TERMINAL STRIPS AND ELECTRICAL CONNECTIONS.....	6
8. FUNCTIONS OF THE BUTTONS ON THE CONTROL PANEL.....	7
9. SETTING OF THE CONFIGURATION PARAMETERS.....	8
10. MESSAGES AND ERROR SIGNALING.....	10
11. CONNECTING THE CONTROLLER TO A COMPUTER AND AVAILABLE SOFTWARE.....	11
12. RS485 COMMUNICATION INTERFACE (acc. to EIA RS-485)	11
13. MODBUS–RTU SERIAL TRANSMISSION PROTOCOL (SLAVE)	12
14. USER'S NOTES	14
CALIBRATION CERTIFICATE.....	15



Please pay particular attention to the text marked with this sign.

The manufacturer reserves the right to make changes to the design and the programming of the device without any deterioration of the technical parameters (some functions may not be available in older versions).

1. SAFETY PRINCIPLES



- before you start to use the device, become familiar with the present instructions;
- in order to avoid electrocution or damage to the device, its mechanical and electrical installation must be performed by qualified workers;
- before switching on the power supply, make sure that all cables and wires are properly connected;
- before making any modifications to the wire and cable connections, switch off the voltage supplied to the device;
- ensure proper operating conditions compliant with the technical specification of the device (chapter 5, power supply voltage, humidity, temperature).

2. INSTALLATION GUIDELINES



The device is designed so as to ensure an appropriate level of immunity to most interferences that may occur in industrial and household environments. In environments of unknown level of interferences, it is recommended to implement the following measures so as to prevent potential interference with the operation of the device:

- a) do not supply the device from the same lines as high-power equipment without using appropriate power line filters;
- b) use shielded supply, sensor, and signal cables, whereby the earthing of the shield should be single-point and located as close to the device as possible;
- c) avoid running measurement (signal) cables in the direct vicinity of and parallel to power and supply cables;
- d) it is recommended to twist the signal wires in pairs or to use a finished twisted-pair cable;
- e) avoid proximity of remotely controlled devices, electromagnetic meters, high power loads, loads with phase or group power control, and other devices that cause high impulse disturbances;
- f) ground or zero metal rails on which rail-mounted devices are installed.

Make sure to remove the protective film from the LCD display before the first use of the device.

3. GENERAL CHARACTERISTICS OF THE TRANSDUCER

- a high class digital relative humidity and temperature sensor with a protective filter (ABS material as a standard, slot width 1 mm, and steel wire mesh with mesh size of 0.15 mm);
- a probe integrated with the enclosure, external or on a stainless steel pipe;
- a current output, 4-20 mA (2-wire, with power supply from the current loop); a voltage output 0-10 V (3-wire), or an RS485 interface;
- calculation of the dew/frost point [°C], relative humidity [g/m³] (calculations for atmospheric pressure of 1,013 hPa) with possibility to link the calculated values to an analog output;
- temperature compensation of humidity measurement, high measurement stability;
- programmable processing ranges for humidity and temperature;
- an LCD display with a keypad (option) that enables configuration of parameters;
- configuration of parameters with the keypad, through the RS485 or PRG port (programmer AR956 or AR955) and free ARsoft-CFG software that enables quick setting and copying of all configuration parameters;
- protection rating IP65 provided by the enclosure which improves reliability of operation thanks to high resistance to penetration of water and dust and surface condensation of steam inside of the device; an IP40 probe;

NOTE:

* periodic calibration of the device in accordance with the requirements in force at the installation site or once every 12 months is recommended



- before you start working with the device, become familiar with this user instruction and make sure the electrical and mechanical systems have been made properly and the correct parameters have been set;
- if the parameters of the transducer have been set using the AR956 programmer, the ARsoft-CFG software must be configured properly.

A detailed description of the configuration parameters of the transducer can be found in chapter 9.

4. CONTENTS OF THE SET

- the transducer;
- a user instruction;
- a warranty card.

5. TECHNICAL DATA

Measurement range for the probe		0÷100 %RH, -30÷80 °C, do not pour water on measuring probe	
The sensor's sheath (ABS sheath and internal stainless steel wire mesh)		mesh size: 0.15 mm; ABS sheath slot width: 1 mm; sheath diameter: 15 mm; sheath length: 40 mm	
Measurement accuracy (same as Sensirion SHT31 sensor)	humidity	typically ±2 %RH in the entire measurement range of transducer	
	temperature	typically ±0.3 °C in the entire measurement range of transducer	
Additional errors	hysteresis	±0.8 %RH at the temperature of 25 °C	
	long-term stability	<0.25 %RH/year (1)	
Response time (τ 63%) to step change of the measured value		8 s (for air flow >3.6 km/h)	
Measurement period		1 s	
LCD display (option)		4 digits, 10 mm high	
Readout measurement resolution		programmable: 0.1 or 1 [%RH, °C, g/m ³]	
Analog outputs (without galvanic separation from power supply)	current 4-20 mA	maximum resolution approx. 14.5 μA; load capacity R _o < (U _{sup} -12) / 22 mA	
	voltage 0-10 V	max. resolution ~ 9.1 mV, load capacity I _o <4.5 mA (R _o >2.5 kΩ)	
	output error	basic < 0.1%; additional ±0.01%/°C of the output range	
Communication interfaces (RS485 and PRG, do not use simultaneously)	PRG programming connection, standard	- speed 2.4 kb/s (0.6÷115.2 kb/s for version with RS485 interface) - character format 8N1 (8 data bits, 1 stop bit, no parity bit)	
	RS485, only in the RS version	- MODBUS-RTU protocol (SLAVE) - without galvanic separation from power supply	
Power supply	version 4÷20 mA	12÷36 VDC (supply from the current loop)	
	version 0÷10 V	18÷30 VDC, current consumption without load on outputs: approx. 7 mA (with and without an LCD)	
	version RS485	9-28 VAC or 9-36 VDC, current consumption approx. 5 mA (with and without an LCD)	
Rated operating conditions	without an LCD	-30 to 80 °C	for humidity <100 %RH (no condensation, do not pour water on the probe)
	with an LCD	-20 to 70 °C	
Operating environment		air and neutral gases	
Enclosure protection rating and mounting method		IP65 (electronic components), IP40 (sensor), wall mounted	

Operating position	any (or the sensor sheath to the ground when the transducer is exposed to the risk of contact with water or water splashes)
Weight	approx. 120 g (with integrated probe)
Electromagnetic compatibility (EMC)	immunity: according to the PN-EN 61000-6-2 standard
	emission: according to the PN-EN 61000-6-4 standard

Notes: (1) - periodic calibration of the device in accordance with the requirements in force at the installation site or once every 12 months is recommended

6. ENCLOSURE DIMENSIONS AND INSTALLATION DATA

a) general data and dimensions of the standard version (integrated probe)

Enclosure type	industrial IP65
Material	polycarbonate
Enclosure dimensions	58 x 94 x 35 mm
Fixing methods	2 x $\Phi 9$ mm holes, distance between the holes 80 mm, narrower part of the hook holder with max. diameter of 5 mm
Conductor cross-sections	1.5 mm ²

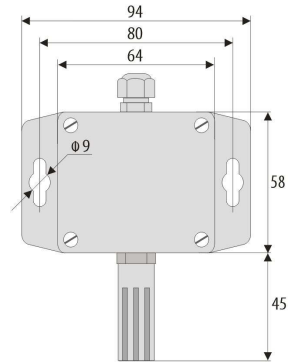

b) dimensions for external probes in different designs

b.1) An external probe with a wire
AR252/2

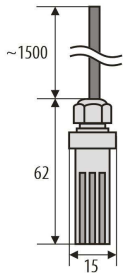

b.2.) A probe on a stainless steel pipe
AR252/L150 or AR252/L250

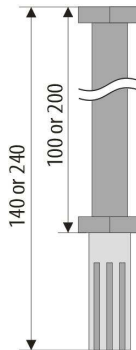

b.3) An external probe in an enclosure with a wire
AR252/3

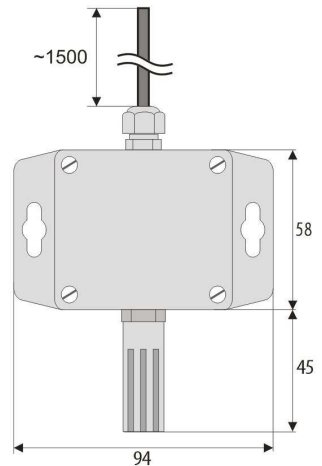

b.4) A probe integrated with the enclosure in the back (channel) design AR252/T

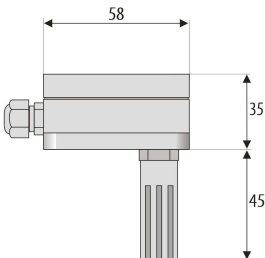

c) installation of cabling

- **cut off the power supply before making any changes to the cabling;**
- remove the 4 screws in the front cover and take it off the device;
- in version with an LCD, **carefully** take out display from bolt connectors (perpendicularly to the front surface);
- terminals to connect power supply cables, outputs cables, and signal cables become accessible – see chapter 7;
- the electric cables must be inserted into the enclosure through cable glands;
- after the device has been mounted and the cabling has been installed, assemble the device carefully performing the work in the reverse order;
- in order to achieve the IP65 rating, the nuts of the cable glands and the enclosure cover must be tightened precisely;

CAUTION: 

In order to avoid any mechanical and electrostatic damage, one must be very careful when handling the circuit board of the display.

7. DESCRIPTION OF TERMINAL STRIPS AND ELECTRICAL CONNECTIONS

Table 7.1. Numbering and description of terminal strips - the version with the current output

Terminals	Description
1	current output ($I_T=4-20$ mA) for the measured value 2 (configurable with parameter 2: [h-2] , chapter 9, Table 9.1), default for temperature
2	current output ($I_H=4-20$ mA) for the measured value 1 (1: [h-1]), default for humidity
3	supply input V+

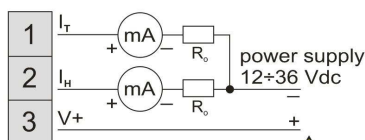

NOTE:

The current loop I_H must ALWAYS be closed, even when it is not in use

Table 7.2. Numbering and description of terminal strips - the version with the voltage output

Terminals	Description
1	voltage output ($U_T=0-10$ V) for the measured value 2 (configurable with parameter 2: [h-2] , chapter 9, Table 9.1), default for temperature
3	voltage output ($U_H=0-10$ V) for the measured value 1 (1: [h-1]), default for humidity
2, 4, 5	common earth (minus for the outputs and the power supply)
6	supply input V+

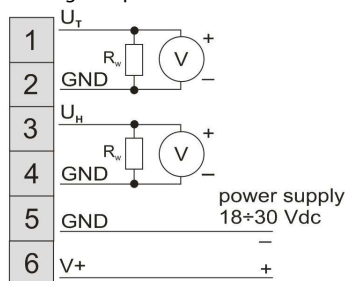
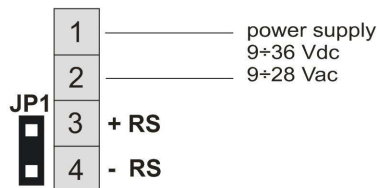



Table 7.3. Numbering and description of terminal strips, version RS485

Terminals	Description
1-2	supply input VAC, VDC
3	+ RS
4	- RS
JP1	electrical jumper terminating the line of the RS485 interface with a 120 Ω resistor (termination is on when the JP1 is shorted)



V+ - power supply voltage

 - measuring device (milliammeter)

 - measuring device (volt meter)

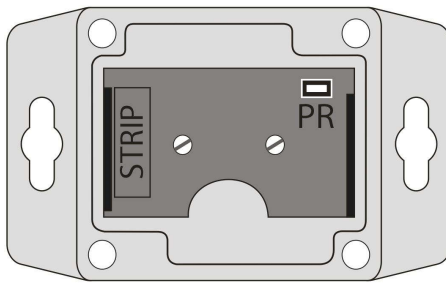



Fig. 7. Location of the terminal strip and the programming socket PR

8. FUNCTIONS OF THE BUTTONS ON THE CONTROL PANEL





Fig. 8. Description of the control panel



a) button functions in the measurement display mode

Button	Description [and marking in the contents of the instructions]
 + 	[UP] and [DOWN] (simultaneously): input in the parameter configuration menu (after hold time longer than 1 s), chapter 9

b) button functions in the parameter configuration menu (chapter 9)

Button	Description [and marking in the contents of the instructions]
	[SET]: - selection of the item displayed in the configuration menu (entering a lower level) - edits the current parameter (the parameter value blinks) - approves and saves the edited parameter value
 or 	[UP] or [DOWN]: - moves to the next or previous parameter (submenu) - changes the value of the edited parameter
 + 	[UP] and [DOWN] (simultaneously): - canceling changes to the edited value (the blinking stops) and return to the previous menu (one level above); - returns to the measurement display mode after hold time longer than 0.5 s.

CAUTION: 

Connecting other devices than the AR955 or AR956 programmer to the PR socket may result in damage to the connected device and the transducer.

9. SETTING OF THE CONFIGURATION PARAMETERS

All the configuration parameters of the device are stored in the non-volatile internal memory.

There are two parameter configuration methods:

1. Using the keypad on the control panel:

- from the mode where the input measurements are displayed in the configuration menu (press the **[UP]** and **[DOWN]** buttons simultaneously for more than 1 second) until the **CONF** message appears
- after entering the main configuration menu (with the message **CONF**) the display shows a mnemonic name of the parameter (**Ch1** <-> **Ch-1** <-> **Ch-2** <->, etc.)
- press the **[UP]** or **[DOWN]** button to go to the relevant parameter
- to change the value of the current parameter, press briefly the **[SET]** button (the parameter blinks in the edition mode)
- use buttons **[UP]** or **[DOWN]** to change the value of the edited parameter;
- approve the changed value of the parameter by pressing the **[SET]** button or cancel it by pressing the **[UP]** and **[DOWN]** buttons (briefly press them simultaneously) - by pressing the **[UP]** and **[DOWN]** buttons again, you will return to the main configuration menu (one level above)
- to exit the configuration: press the **[UP]** and **[DOWN]** buttons for a long moment or wait approx. 2 minutes

2. Use the AR956 programmer and the ARSOFT-CFG software to:

- connect the device to a computer port and to start and configure the ARSOFT-CFG application;
- after the connection has been established, the current measured values and are displayed in the software's window;
- setting and viewing of the device parameters is possible in the parameter edition window;
- new parameter values must be approved with the **Approve changes** button;
- the current configuration can be saved in a file or set using values read from a file;

NOTE:



- before disconnecting the device from a computer, press the **Disconnect device** button (ARSOFT-CFG);
- in the event of no response:
 - in the **Program options** check the configuration of the port and the **MODBUS address of the device** (transmission speed 2,400 bit/s, address MODBUS=1);
 - make sure that the serial port drivers in the computer have been properly installed for the AR956 programmer;
 - disconnect for a few seconds and then reconnect the AR956 programmer;
 - restart the computer;
 - if the AR955 programmer is used instead of the AR956 programmer, connect the power supply voltage to the transducer.

If a difference is found between the indications and the actual measured values, it is possible to tune the zero and the sensitivity for the specific sensor: parameters **Ch1**, **Ch2** (calibration of the zero point) and **Ch1**, **Ch2** (calibration of the inclination).

In order to restore the default settings, use the file with the default configuration in the ARSOFT-CFG software.

NOTE:



The transmission parameters for the AR956 programmer in the ARSOFT-CFG software are the following: 2,400 bit/s, address MODBUS = 1

Table 9.1. Configuration parameters for the version with the 4-20 mA current output or the 0-10 V voltage output

Parameter	Range of variability of the parameter and description		Default settings
0: 000 display indication resolution (1)	0	resolution 1 [%RH, °C, g/m ³]	1
	1	resolution 0.1 [%RH, °C, g/m ³]	
1: ch-1 the first displayed value and the signal of the output I _H or U _H (chapter 7, Tables 7.1 and 7.2)	rEHU	measured relative humidity [%RH]	rEHU [%RH]
	tEAT	measured sensor temperature [°C]	
	AbHU	calculated absolute humidity [g/m ³] (2)	
	dEPT	calculated dew/frost point temperature [°C] (2)	
2: ch-2 the second displayed value and the signal of the output I _T or U _T (chapter 7, Tables 7.1 and 7.2)	rEHU	measured relative humidity [%RH]	tEAT [°C]
	tEAT	measured sensor temperature [°C]	
	AbHU	calculated absolute humidity [g/m ³] (2)	
	dEPT	calculated dew/frost point temperature [°C] (2)	
3: dPER displayed values switching period	10 ÷ 100	display time of the values selected with parameters 1: ch-1 and 2: ch-2 (3)	40 s
4: H L0 the lower value of the measurement range of the output I _H or U _H (chapter 7)	-500 ÷ 1000	unit depending on the setting of parameter 1: ch-1	00 [%RH]
5: H H1 the upper value of the measurement range of the output I _H or U _H	-500 ÷ 1000	unit depending on the setting of parameter 1: ch-1	1000 [%RH]
6: t L0 the lower value of the measurement range of the output I or U _T	-500 ÷ 1000	unit depending on the setting of parameter 2: ch-2	-300 [°C]
7: t H1 the upper value of the measurement range of the output I or U _T	-500 ÷ 1000	unit depending on the setting of parameter 2: ch-2	000 [°C]
8: c0H1 calibration of the zero point for humidity [%RH]	-200 ÷ 200	zero point offset	00 [%RH]
9: c0H1 calibration of the inclination for humidity [%RH]	-150 ÷ 150	sensitivity (gain)	00 [%]
10: c0t2 calibration of the zero point for temperature [°C]	-200 ÷ 200	zero point offset	00 [°C]
11: c0t2 calibration of the inclination for temperature [°C]	-150 ÷ 150	sensitivity (gain)	00 [%]

Notes: (1) - applies only do display of data on the control panel

(2) - values calculated based on measurement of relative humidity (%RH) and temperature (°C) for atmospheric pressure P=1013 hPa

(3) - in order to display the value of only one type, the following condition must be met: **ch-1** = **ch-2**

Table 9.2. Configuration parameters for the RS485 version

Parameter	Range of variability of the parameter and description		Default settings
0: 001 position of the point/resolution(1)	0	resolution 1 [%RH, °C, g/m ³]	0
	1	resolution 0.1 [%RH, °C, g/m ³]	
1: ch-1 first displayed value	rRH	measured relative humidity [%RH]	rRH [%RH]
	tSP	measured sensor temperature [°C]	
	ah	calculated absolute humidity [g/m ³] (2)	
	dP	calculated dew/frost point temperature [°C] (2)	
2: ch-2 second displayed value	rRH	measured relative humidity [%RH]	tSP [°C]
	tSP	measured sensor temperature [°C]	
	ah	calculated absolute humidity [g/m ³] (2)	
	dP	calculated dew/frost point temperature [°C] (2)	
3: dPER displayed values switching period	10 ÷ 100	display time of the values selected with parameters 1: ch-1 and 2: ch-2 (3)	40 s
4: coH-1 calibration of the zero point for humidity [%RH]	-200 ÷ 200	zero point offset	00 [%RH]
5: coH-1 calibration of the inclination for humidity [%RH]	-150 ÷ 150	sensitivity (gain)	00 [%]
6: coT-2 calibration of the zero point for temperature [°C]	-200 ÷ 200	zero point offset	00 [°C]
7: coT-2 calibration of the inclination for temperature [°C]	-150 ÷ 150	sensitivity (gain)	00 [%]
8: ADDR MODBUS address	1 ÷ 247	MODBUS address of the device	1
9: br transmission speed	06 ÷ 152	transmission speed [kb/s], for the RS485 and the AR956 programmer	24

- Notes:**
- (1) - applies only do display of data on the control panel
 - (2) - values calculated based on measurement of relative humidity (%RH) and temperature (°C) for atmospheric pressure P=1013 hPa
 - (3) - in order to display the value of only one type, the following condition must be met: **ch-1 = ch-2**

10. MESSAGES AND ERROR SIGNALING

a) measurement errors:

Code	Possible causes of error
---	the measurement range of the sensor is exceeded from the top
---	the measurement range of the sensor is exceeded from the bottom
---	no communication with the sensor (the sensor is defective or the electrical connections are broken)

b) other messages:

Code	Description of message
conf	the parameter configuration menu was accessed

11. CONNECTING THE CONTROLLER TO A COMPUTER AND AVAILABLE SOFTWARE

It may be useful (or necessary) to connect the transducer to a computer in order to configure parameters, which also enables copying the setting to other transducers of the same type.

As a standard, the transducers are equipped with a **PR** port which enables connection to a computer using an AR956 programmer using the MODBUS-RTU communication protocol and the following transmission parameters: speed = 2,400 bit/s, MODBUS address = 1.

The following application is available (on a CD supplied with the AR956 programmer or to be downloaded from the Internet at www.apar.pl, "Download" section, for operating systems Windows Vista/7/8/10):

Name	Software description
ARsoft-CFG (free)	<ul style="list-style-type: none"> - display of current measurement data from the connected device - setting configuration parameters, such as the measurement signal, the indication range, the options, the display, etc. - creation on the disk of a "cfg" file with the current configuration of the parameters for future use (copying of configuration) - the software requires communication with the device via the PR port (AR956 or AR955)

A detailed description of the aforementioned application can be found in the installation folder.

NOTE:

Before a connection is established, make sure that the MODBUS address and the transmission speed in the options of the ARsoft software are the same as the settings of the device (this applies to the version with the RS485).

Moreover, in the options of the ARsoft software, set the number of the COM serial port in use (in the case of the AR956/AR955 programmer or the RS485/USB converter, it is the number assigned by the operating system during installation of the drivers).

12. RS485 COMMUNICATION INTERFACE (acc. to EIA RS-485)

The installation specification for the RS485- standard interface is the following:

- maximum cable length - 1 km (observe the installation guidelines, chapter 2, sub-items b, c, and d)
- maximum number of devices in a RS485 line - 30, in order to increase the number, use RS485/RS/485 amplifiers
- termination and polarizing resistors when the MASTER is at the start of the line (Fig. 12):
 - at the start of the line - 2 x 820 Ω to the ground and +5 V of the MASTER and 150 Ω between lines
 - at the end of the line - 150 Ω between lines
- termination and polarizing resistors when the MASTER is in the center of the line:
 - at the converter - 2 x 820 Ω , to the ground and +5 V of the converter
 - at both ends of the line - 150 Ω each between lines

Equipment from different manufacturers that form the RS485 network (e.g. RS485 converters/USB) may have integrated polarizing and terminating resistors; in such a case there is no need to use external elements.

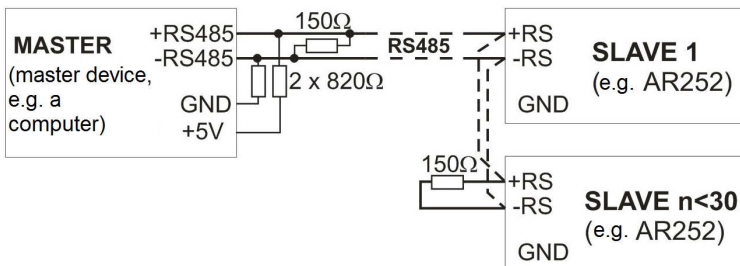

Fig. 12. Pictorial diagram of the RS485 network

13. MODBUS–RTU SERIAL TRANSMISSION PROTOCOL (SLAVE)

Character format : 8 bits, 1 stop bit, no parity bit

Available functions : READ - 3 or 4, WRITE - 6

Table 13.1. Query frame format for the READ function (frame length - 8 bytes):

address of the device	function 4 or 3	read register address: 0 ÷ 29 (0x001D)	number of read registers: 1 ÷ 30 (0x0010)	CRC check sum
1 byte	1 byte	2 bytes (HB-LB)	2 bytes (HB-LB)	2 bytes (LB-HB)

Example 13.1. Reading of a register with address 0: 0x01 - 0x04 - 0x0000 - 0x0001 - 0x31CA

Table 13.2. Query frame format for the WRITE function (frame length - 8 bytes):

address of the device	function 6	write register address: 0 ÷ 29 (0x001D)	write register value	CRC check sum
1 byte	1 byte	2 bytes (HB-LB)	2 bytes (HB-LB)	2 bytes (LB-HB)

Example 13.2. Entry in a register with address 10 (0xA) with the 0 value: 0x01 - 0x06 - 0x000A - 0x0000 - 0xA9C8

Table 13.3. Response frame format for the READ function (minimum frame length - 7 bytes):

address of the device	function 4 or 3	number of bytes in the data field (max. 30*2=60 bytes)	data field - register value	CRC check sum
1 byte	1 byte	1 byte	2 ÷ 60 bytes (HB-LB)	2 bytes (LB-HB)

Example 16.3. Response frame for register value equal to 0: 0x01 - 0x04 - 0x02 - 0x0000 - 0xB930

Table 13.4. Response frame format for the WRITE function (frame length - 8 bytes):

copy of the claim frame for the WRITE function (Table 16.2)

Table 13.5. Special answer (errors: function field = 0x84 or 0x83 in the case of the READ function and 0x86 in the case of the WRITE function):

Error code (HB-LB in the data field)	Error description
0x0001	non-existing register address
0x0002	wrong write register value
0x0003	improper function number

Example 13.5. Error frame for a non-existing read register address:

0x01 - 0x84 - 0x02 - 0x0001 - 0x5130

Table 13.6. Maps of registers for the MODBUS-RTU protocol for the transducer version with the RS485

Register address HEX (DEC)	Value (HEX or DEC)	Description of register and access type (R- read only register, R/W - read and write register)	
0x00 - 0x05	0	not used or reserved (for compatibility with the older version)	
0x06 (6)	0 ÷ 1000	measured value of relative humidity [%RH]	value in the U2 code , without a decimal point (resolution 0.1 [%RH, °C, g/m ³])
0x07 (7)	-300 ÷ 800	measured value of temperature [°C]	
0x08 (8)	0 ÷ 999	calculated value of relative humidity [g/m ³]	
0x09 (9)	-300 ÷ 1000	calculated value of dew/frost point [°C]	
0x0A ÷ 0x13	0	not used or reserved	
Configuration parameters (chapter 9, Table 9.2)			
0x14 (20)	0 ÷ 1	parameter 0: 000 position of the period, resolution of the display	R/W
0x15 (21)	0 ÷ 3	parameter 1: 000 first displayed value	R/W
0x16 (22)	0 ÷ 3	parameter 2: 000 second displayed value	R/W
0x17 (23)	10 ÷ 100	parameter 3: 000 displayed values switching period	R/W
0x18 (24)	-200 ÷ 200	parameter 4: 000 calibration of the zero point for humidity	R/W
0x19 (25)	-150 ÷ 150	parameter 5: 000 calibration of the inclination for humidity	R/W
0x1A (26)	-200 ÷ 200	parameter 6: 000 calibration of the zero point for temperature	R/W
0x1B (27)	-150 ÷ 150	parameter 7: 000 calibration of the inclination for temperature	R/W
0x1C (28)	1 ÷ 247	parameter 8: 000 MODBUS address	R/W
0x1D (29)	0 ÷ 9	parameter 9: 0 transmission speed	R/W

Calibration Certification

Name and address of the manufacturer: **Sensirion AG**
Laubisruetistrasse 50
CH-8712 Switzerland

Description: Digital Humidity- and Temperature Sensors

- SHT1x
- SHT3x
- SHTC1
- STS21
- SHT2x
- SHT7x
- SHTW1
- STSC1

The above mentioned products are calibrated to meet the specifications according to the corresponding Sensirion data sheet. Each device is individually tested after its calibration.

Sensirion uses transfer standards for the calibration. These transfer standards are themselves subject to a scheduled calibration procedure. The calibration of the reference itself used for the calibration of the transfer standards is performed by an ISO/IEC 17025 accredited laboratory.

The accreditation body is full member of the International Laboratory Accreditation Cooperation (www.ilac.org). Calibration certificates issued by facilities accredited by a signatory to the ILAC Mutual Recognition Arrangement (MRA) are accepted by all signatories to the ILAC MRA.

This provides traceability of measurement to recognized national standards and to units of measurement realized at the "National Physical Laboratory" (NPL) or other recognized national standards laboratories like "Physikalisch-Technische Bundesanstalt" (PTB) or "National Institute of Standards and Technology" (NIST).

Staeafa, November 2015



Stephan Weber,
Director,
Head of Quality Management, Sensirion AG



Volker Born
Manager,
Head of Quality Engineering, SensirionAG

