

EYE BOX

enclosures for electronic



INDICE / INDEX

PRODOTTI E FUNZIONI / PRODUCTS & FUNCTIONS

- 08 Eye box **intro**
- 10 Eye box **display**
- 14 Eye box **dimmer**
- 18 Eye box **basic**
- 20 Eye box human presence **basic e lighting sensor**
- 24 Eye box **camera**
- 28 Eye box **gas sensor**
- 32 Eye box **speaker**

ACCESSORI E PERSONALIZZAZIONI / ACCESSORIES & CUSTOMISATION

- 36 Accessorio placca / *Plaque accessory*
- 38 Supporti Eye box / *Eye Box supports*
- 44 Finitura ghiera / *Ring nut finish*
- 46 Personalizzazione colore / *Colour customisation*

AVVISO

Italtronic ha già realizzato EYE BOX basic mentre, le altre versioni, vengono presentate nel seguente catalogo come possibili idee di sviluppo.

NOTICE

Italtronic is already producing EYE BOX basic while the other versions are presented in this catalogue as potential development ideas.

**Style. Colour.
Innovation.**



8

models

∞

combinations



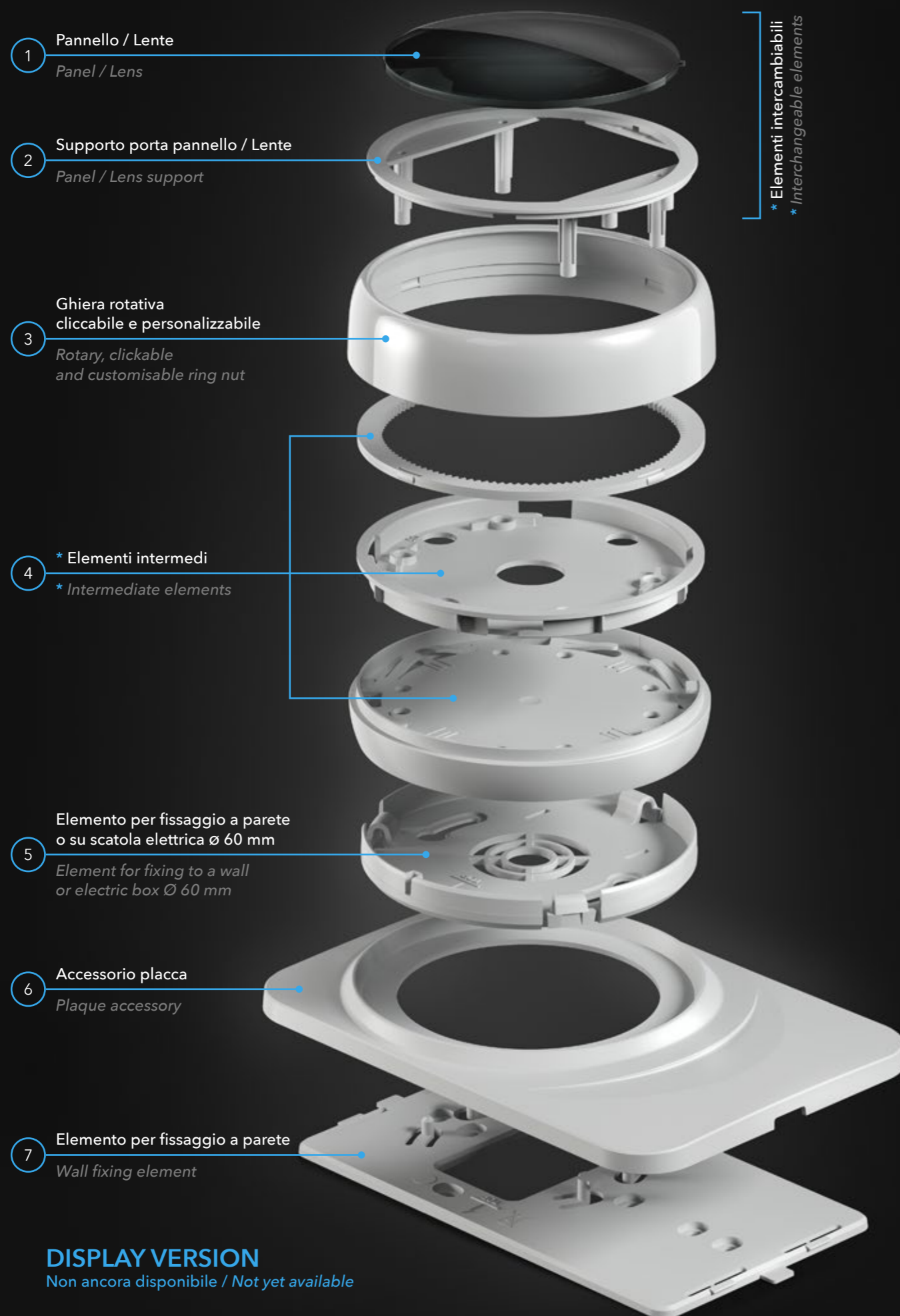

DISPLAY VERSION

Non ancora disponibile / Not yet available

PROGETTATO PER ADERIRE ALLE TUE ESIGENZE

A servizio della tecnologia.

EYE BOX esprime la nuova frontiera di ITALTRONIC collegando il mondo industriale delle applicazioni per HOME & BUILDING AUTOMATION al valore del design dell'oggetto tecnologico, ampliandone la personalizzazione fino a renderlo esclusivo.

Il contenitore assume una forte caratterizzazione estetica, un aspetto finale accattivante ed è concepito per trasmettere un'emozione. Il nuovo concept permette al consumatore di interagire in modo funzionale e confortevole. Un mix consapevole di tecnologia e design.

Italtronic ha già realizzato EYE BOX basic mentre, le altre versioni, vengono presentate nel seguente catalogo come possibili idee di sviluppo. Partendo dal prodotto base, si potrà dare origine ad un'ampia gamma di soluzioni completamente personalizzabili.

Non solo molteplici colori e finiture ma una completa personalizzazione del frontale o della ghiera rotativa di regolazione, per ottenere molteplici prodotti con funzionalità diverse e uniche nel loro genere. Lo sviluppo consente molteplici connessioni a parete, sia elettriche che meccaniche, risolvendo la maggior parte delle necessità dei progettisti elettronici.

DESIGNED TO SATISFY YOUR NEEDS

Serving technology.

EYE BOX is the new frontier for ITALTRONIC, joining the industrial world of HOME & BUILDING AUTOMATION applications with the design value of something technological, increasing the customization level to make it exclusive.

The enclosure has a highly impacting and attractive appearance, designed to transmit emotion. A new concept where the consumer is able to interact in a very functional and convenient way. An expert mix of technology and design.

Italtronic is already producing EYE BOX basic while the other versions are presented in this catalogue as potential development ideas. Starting with the basic product, you can create a vast range of totally customizable solutions.

Not just numerous colours and finishes, but total customization of the front panel or the regulation, generating numerous products with different and unique functions. Development enables various electrical and mechanical wall connections, which solve the majority of electronic designers' needs.

* Gli elementi intercambiabili e intermedi sono dipendenti dalla configurazione prescelta.

* The interchangeable and intermediate elements depend on the chosen configuration.

EYE BOX DISPLAY



Controllo a prova di futuro.

La versione **EYE BOX DISPLAY** è la più evoluta. Il contenitore consente l'alloggiamento di un monitor da 4,3 pollici rettangolare. Grazie alla stampa tampografica interna si può ottenere una forma circolare per una visione a "tutto tondo".

Future proof control.

EYE BOX DISPLAY is the most advanced version. The enclosure can house a 4.3 inch rectangular screen. With the interior pad printing, a circular form can be obtained for all-round viewing.



tampografia versione tonda / round version pad printing



Lente trasparente / stampa iride nero
Transparent lens / black iris print



Lente trasparente / stampa iride bianco
Transparent lens / white iris print



Lente bianca / stampa iride bianco
White lens / white iris print

tampografia versione rettangolare / rectangular version pad printing



Lente trasparente / stampa iride nero
Transparent lens / black iris print



Lente trasparente / stampa iride nero
Transparent lens / black iris print



rotation

Ruotando la ghiera si possono scorrere e visualizzare le diverse opzioni. Mediante una **semplice pressione sulla ghiera** è possibile attivarle e convalidarle.



push

Turn the ring nut to scroll and see the different options. **Just push the ring nut** to activate and share them.

VERSIONI / VERSIONS

EYE BOX display

EYE BOX DISPLAY consente di personalizzare graficamente la lente ottenendo un effetto "iride" o qualsiasi vostra preferenza espressiva. Le personalizzazioni grafiche infatti, possono essere studiate ad hoc dal committente per ottenere un display unico nel suo genere. Il display alloggiato è di forma rettangolare, la forma tonda viene definita da una tampografia interna eseguita nella lente.

EYE BOX DISPLAY gives graphic lens customisation, to create an "iris" effect or whatever effect you prefer.

In fact, the graphic customization can be studied exclusively for the customer to create a unique display.

The display itself is rectangular, while the round shape is given by internal pad printing inside the lens.

Area visibile display

Display visible area

Area lente tampografata

Pad printed lens area



DISPLAY

Il contenitore consente l'alloggiamento di un display da 4.3". Può essere DOMOTICO A COLORI, raffigurato da SOLE ICONE o MONOCROMATICO CON SOLI NUMERI.

DISPLAY

The enclosure can house a 4.3 inch display. You can have COLOUR HOME AUTOMATION, depicted with JUST ICONS, or MONOCHROME WITH JUST NUMBERS.

LENTE

La lente trasparente consente tre tipologie di stampa: TAMPOGRAFICA AD 1 COLORE, DIGITALE e SERIGRAFICA MULTICOLORE. Inoltre è disponibile anche una lente effetto "milk".

LENS

The transparent lens allows three types of printing: COLOUR PAD PRINTING, DIGITAL OR MULTICOLOUR SCREEN PRINTING. There is also the "milk" effect lens.



Display domotico a colori
Colour home automation display



Display solo icone
Just icon display



Display monocromatico numeri
Monochrome numeric display



Lente tampografata 1 colore
Pad printed lens 1 colour

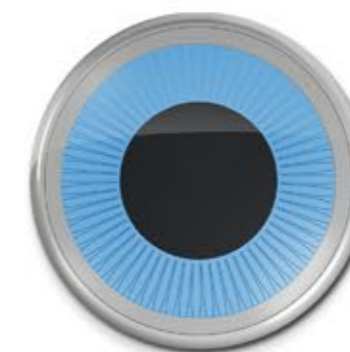

Lente con stampa digitale
Lens with digital printing



Lente serigrafata multicolore
Lens with multicolour screen printing



EYE BOX DIMMER



Perfetta unione tra estetica e funzionalità.

EYE BOX DIMMER è un solido contenitore, predisposto per il fissaggio a parete e connessioni elettriche, utile allo sviluppo di applicazioni semplici che non prevedono la visualizzazione ma più comunemente la rilevazione o la trasmissione di dati anche via Wi-Fi.

Perfect union of design and functions.

***EYE BOX DIMMER** is a robust enclosure, designed for fixing to the wall and with electric connections, useful to develop simple applications that do not require display, but just detection or data transmission via Wi-Fi.*



rotation

Ruotando la ghiera si possono scorrere e visualizzare le diverse opzioni. Mediante una **semplice pressione sulla ghiera** è possibile attivarle e convalidarle.

Contatto:

Contattateci direttamente in azienda, tramite la nuova CHAT-LINE o alla e-mail: dir@italtronic.com. Saremo a vostra disposizione per comprendere i Vostri target estetici, di engineering e di costo e per eseguire un campione gratuito.



push

Turn the ring nut to scroll and see the different options. **Just push the ring nut** to activate and share them.

Contact:

Contact our company directly either on our new Chat Line or by email to dir@italtronic.com. We are at your disposition to understand what your design, engineering and cost targets are and to prepare a free sample.

VERSIONI / VERSIONS

EYE BOX dimmer

Proponiamo in queste pagine alcuni disegni esplicativi di possibili personalizzazioni. Attualmente queste varianti non sono già state prototipate. Siamo disponibili però al loro sviluppo se dovessero incontrare, in modo positivo, il Vostro gusto estetico e la Vostra necessità tecnologica. Eseguiremo qualsiasi personalizzazione suggerita dai Vostri architetti o designer.

These pages show some explanatory drawings for customisations. These variants have not had prototypes made yet, but we are prepared to develop them if they appeal to your design and technology needs. We will apply any customization that your architects or designers suggest.

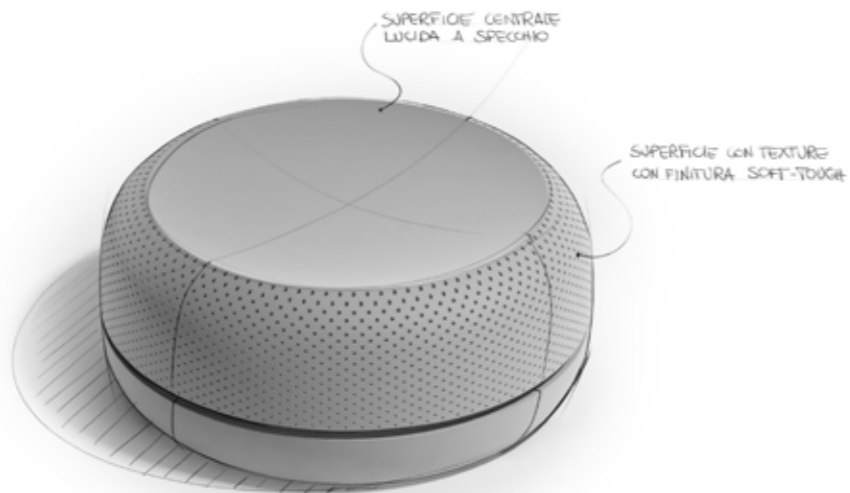

A

B

C

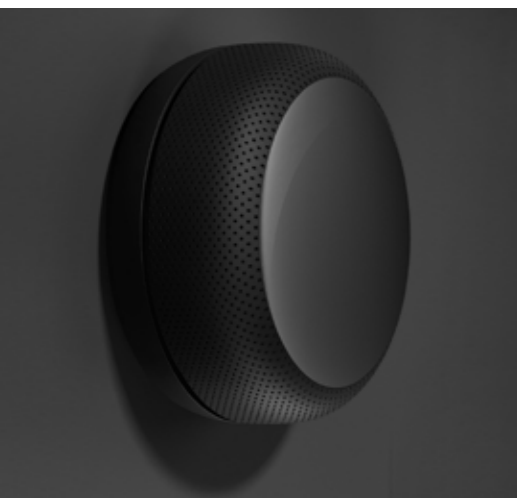

A

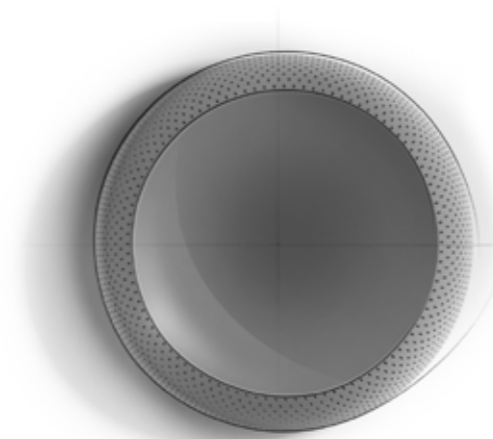

front view



side view

B

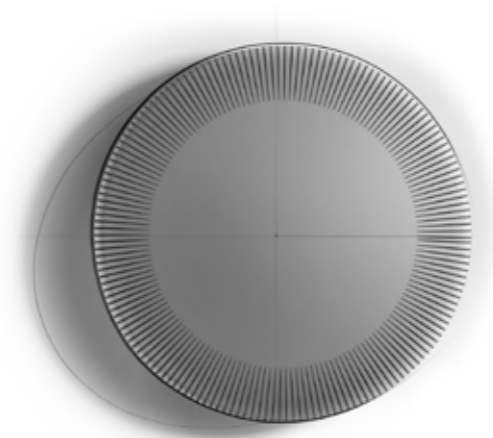

front view



side view

C

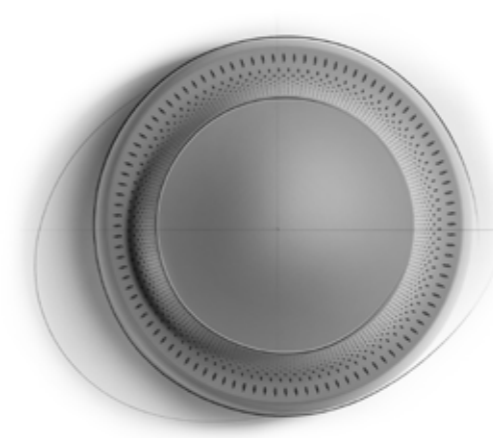

front view



side view

EYE BOX BASIC



La semplicità incontra il design.

Il contenitore **EYE BOX BASIC** mantiene lo stesso family feeling della versione display e dimmer. Viene realizzato in ABS bianco, compreso il pannello superiore ed è fisso.

Esternamente le linee sono volutamente minimali. Internamente le funzioni tecniche sono limitate ma al cliente viene garantita una completa personalizzazione di forma, colore e grafica. Essendo notevolmente più semplice della versione DISPLAY, il costo è sensibilmente più basso specialmente per quantità medio-alte.

Simplicity meets design.

*The **EYE BOX BASIC** enclosure has the same family feeling as the display and dimmer version. It is made in white ABS, including the top panel, and is fixed.*

Purposely minimalist exterior lines, inside the technical functions are limited but the customer is assured total customization of shape, colour and graphics. As it is considerably simpler than the DISPLAY model the cost is also much lower, especially for medium-high quantities.



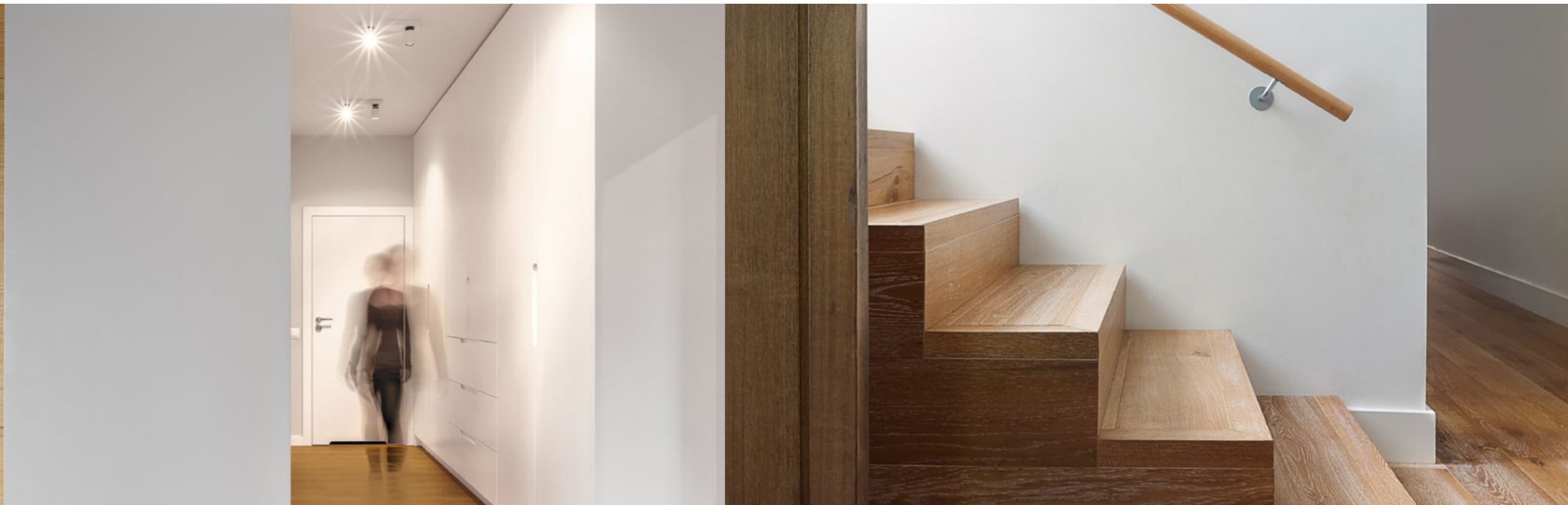

EYE BOX HUMAN PRESENCE



Basic sensor.

EYE BOX Human Presence nella versione BASIC è stato ideato per alloggiare una cupola con sensore di rilevazione presenza. Le caratteristiche meccaniche e di connessione elettrica sono le medesime degli altri contenitori. Il design estetico può essere personalizzato su Vostra richiesta.

Basic sensor.

EYE BOX Human Presence in the BASIC version is designed to house a dome with presence sensor. The mechanical features and electric connections are the same as the other enclosures. The exterior design can be customised to your request.



EYE BOX HUMAN PRESENCE



Lighting sensor.

EYE BOX Human Presence LIGHTING SENSOR differisce dalla versione BASIC per l'implementazione di led luminosi. Anche per questa versione le caratteristiche meccaniche e di connessione elettrica sono le medesime e il design può essere personalizzato su Vostra richiesta.

Lighting sensor.

EYE BOX Human Presence LIGHTING SENSOR differs from the BASIC version as led lights are used. The mechanical features and electric connections are the same as the other enclosures for this version as well, and the exterior design can be customised to your request.



VERSIONI

EYE BOX human presence

Proponiamo in queste pagine alcuni disegni esplicativi di possibili personalizzazioni. Attualmente queste varianti non sono già state prototipate. Siamo disponibili però al loro sviluppo se dovessero incontrare, in modo positivo, il Vostro gusto estetico e la Vostra necessità tecnologica. Eseguiremo qualsiasi personalizzazione suggerita dai Vostri architetti o designer.

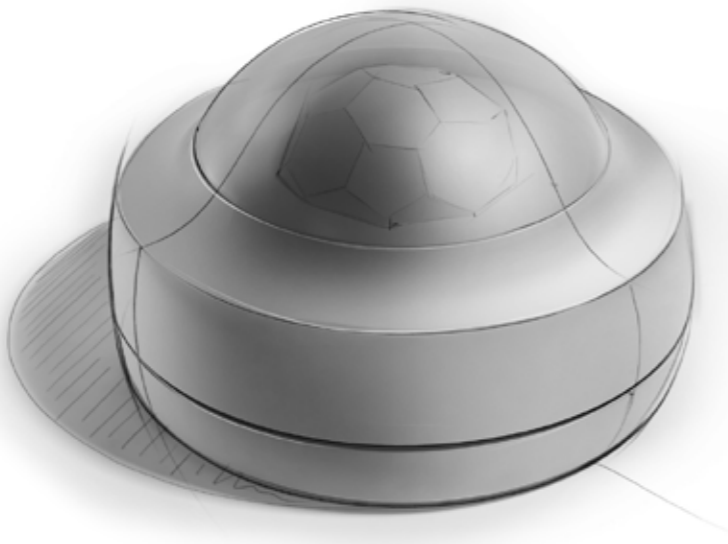
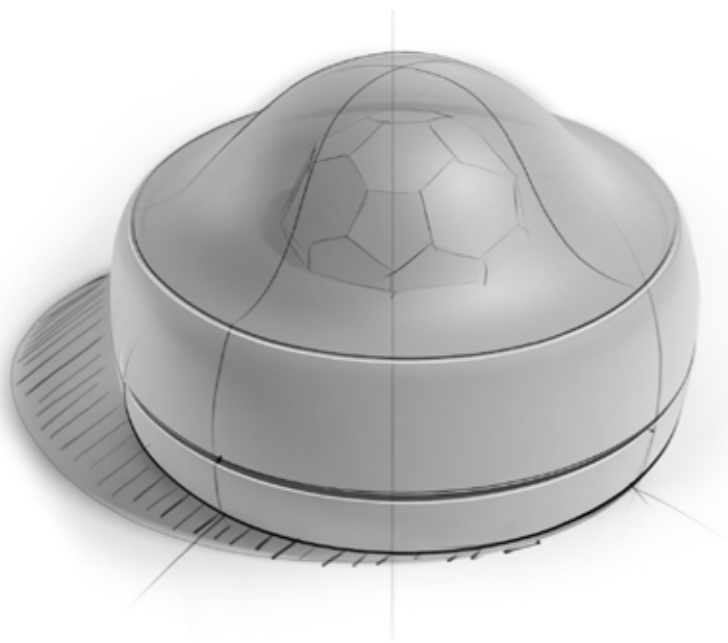

VERSIONS

EYE BOX human presence

These pages show some explanatory drawings for customisations. These variants have not had prototypes made yet, but we are prepared to develop them if they appeal to your design and technology needs. We will apply any customization that your architects or designers suggest.

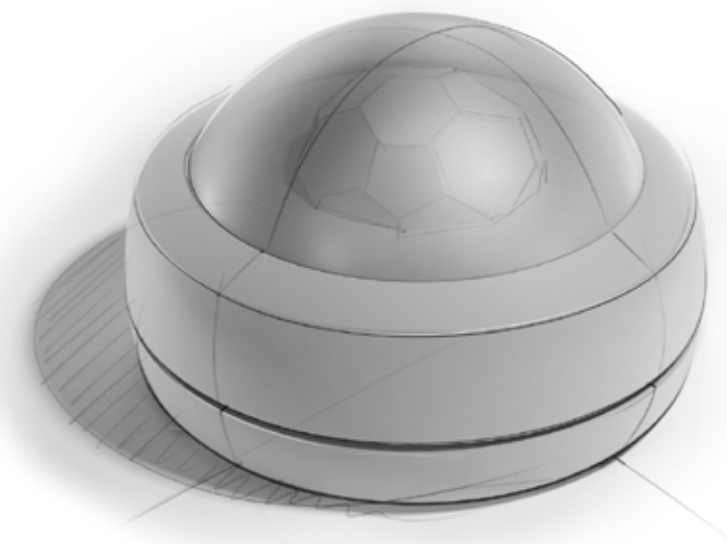
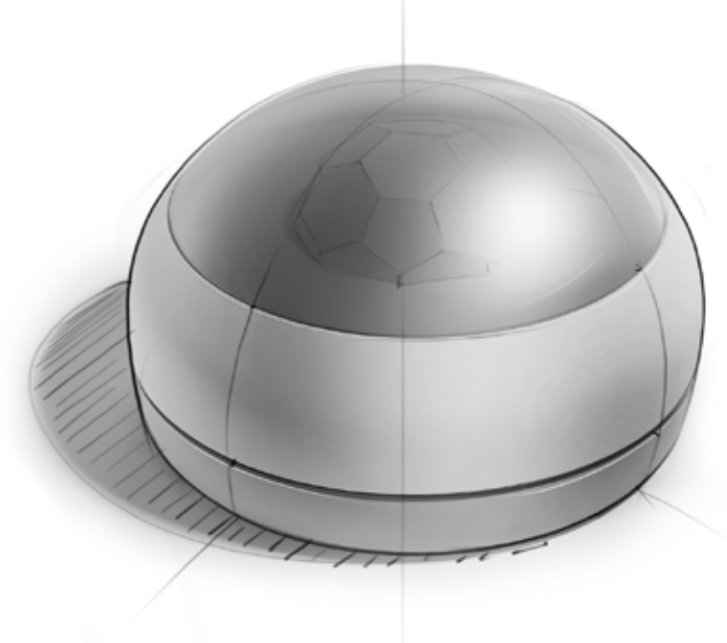

EYE BOX CAMERA



I dettagli fanno la differenza.

EYE BOX CAMERA è stato concepito per alloggiare una cupola con telecamera standard. Abbiamo voluto sviluppare un design in linea con gli altri contenitori della gamma EYE BOX ma è possibile modificare l'estetica del contenitore e della cupola per contenere una telecamera o una tecnologia personalizzata.



The details make the difference.

EYE BOX CAMERA is designed to house a dome with a standard camera. We wanted to develop a design in line with the other range of EYE BOX enclosures, but being able to alter the enclosure and dome design in order to house a customized camera or technology.



VERSIONI / VERSIONS

EYE BOX camera

Proponiamo in queste pagine alcuni disegni esplicativi di possibili personalizzazioni. Attualmente queste varianti non sono già state prototipate. Siamo disponibili però al loro sviluppo se dovessero incontrare, in modo positivo, il Vostro gusto estetico e la Vostra necessità tecnologica. Eseguiremo qualsiasi personalizzazione suggerita dai Vostri architetti o designer.

These pages show some explanatory drawings for customisations. These variants have not had prototypes made yet, but we are prepared to develop them if they appeal to your design and technology needs. We will apply any customization that your architects or designers suggest.





EYE BOX GAS SENSOR

Un'estetica affidabile.

EYE BOX GAS SENSOR non è ancora disponibile ma siamo a vostra disposizione per analizzare con Voi uno sviluppo alternativo per l'adattamento a sensori più complessi e/o estetiche più accattivanti.

Reliable design.

EYE BOX GAS SENSOR is not yet available, but we are ready to analyse an alternative development together with you, in order to adapt to more complex sensors or captivating designs.

VERSIONI / VERSIONS

EYE BOX gas sensor

Proponiamo in queste pagine alcuni disegni esplicativi di possibili personalizzazioni. Attualmente queste varianti non sono già state prototipate. Siamo disponibili però al loro sviluppo se dovessero incontrare, in modo positivo, il Vostro gusto estetico e la Vostra necessità tecnologica. Eseguiremo qualsiasi personalizzazione suggerita dai Vostri architetti o designer.

These pages show some explanatory drawings for customisations. These variants have not had prototypes made yet, but we are prepared to develop them if they appeal to your design and technology needs. We will apply any customization that your architects or designers suggest.

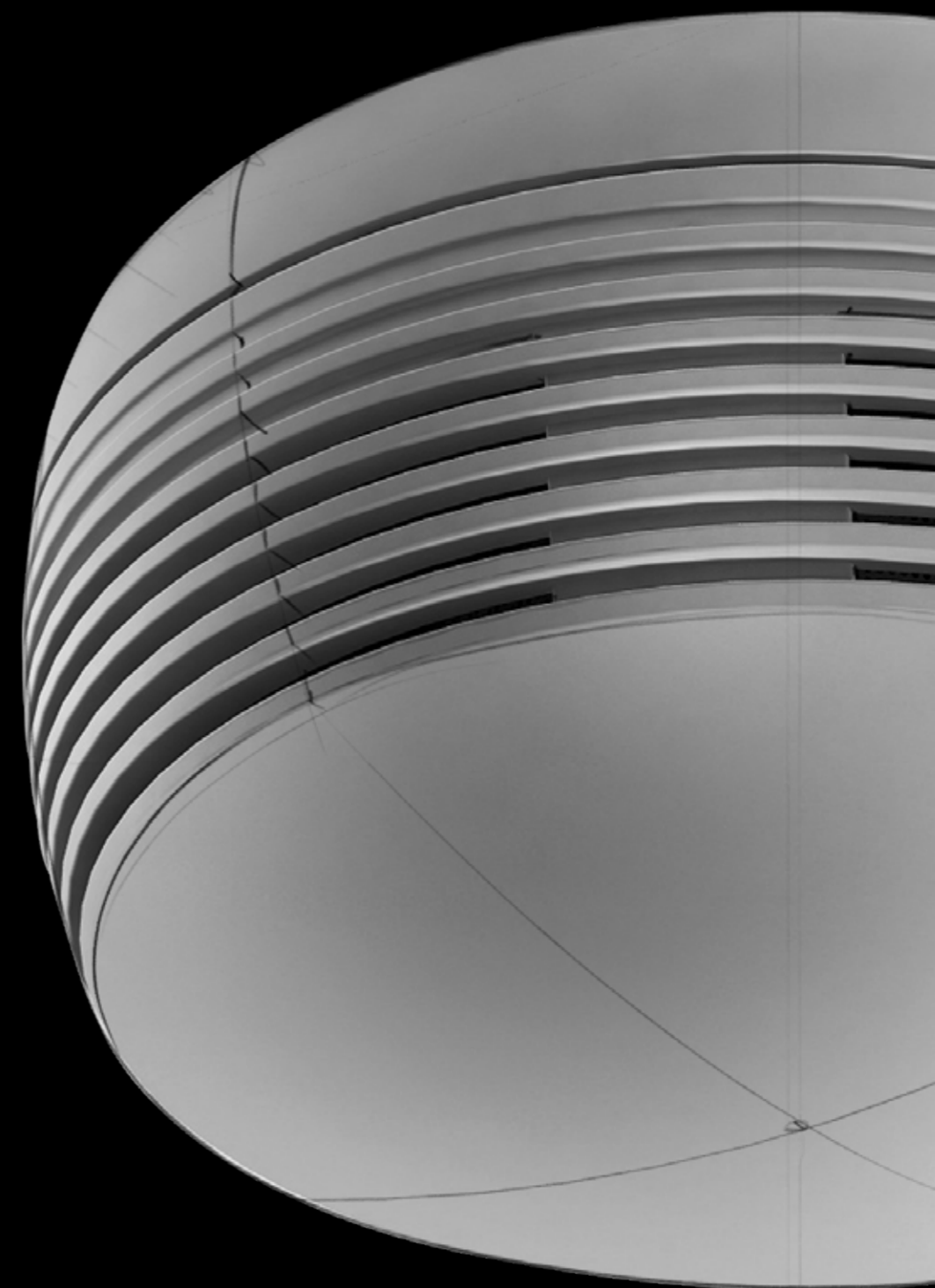



EYE BOX SPEAKER



La nuova dimensione del suono.

EYE BOX SPEAKER, a completamento della gamma, offre versioni dal design accattivante. Nella parte posteriore può essere equipaggiato per il fissaggio meccanico a parete ed elettrico nelle versioni più comuni.

Non è ancora disponibile, ma i tempi di realizzazione potrebbero essere brevi, se intervenissimo solo con delle semplici lavorazioni meccaniche CNC, sul nostro contenitore EYE BOX BASIC.

The new sound dimension.

To complete the range, **EYE BOX SPEAKER** offers some very attractive versions. The back can be equipped for mechanical fixing to the wall and electric connections in the more common versions.

It is not yet available, but production time could be very short if we just add some simple CNC mechanical processes to our EYE BOX BASIC enclosure.



VERSIONI / VERSIONS

EYE BOX speaker

Proponiamo in queste pagine alcuni disegni esplicativi di possibili personalizzazioni. Attualmente queste varianti non sono già state prototipate. Siamo disponibili però al loro sviluppo se dovessero incontrare, in modo positivo, il Vostro gusto estetico e la Vostra necessità tecnologica. Eseguiremo qualsiasi personalizzazione suggerita dai Vostri architetti o designer.

These pages show some explanatory drawings for customisations. These variants have not had prototypes made yet, but we are prepared to develop them if they appeal to your design and technology needs. We will apply any customization that your architects or designers suggest.

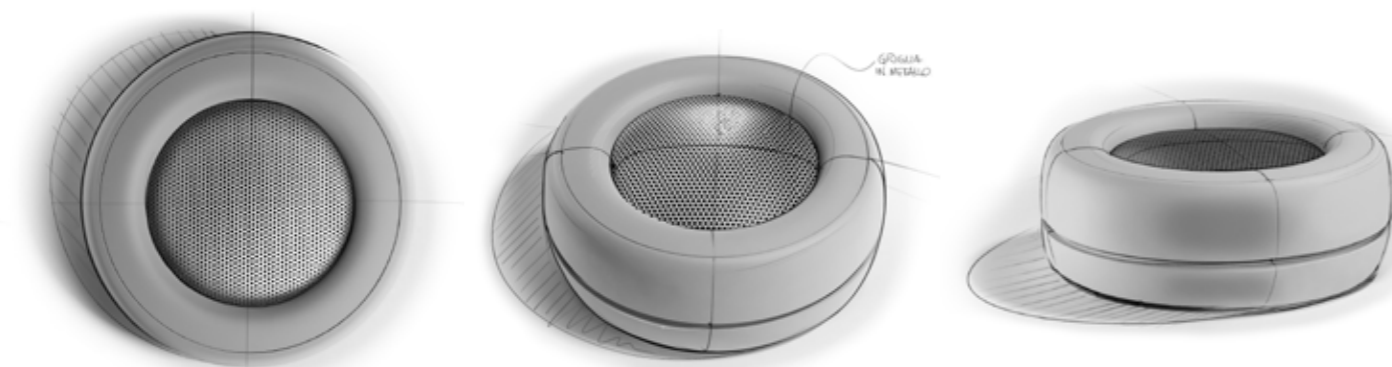
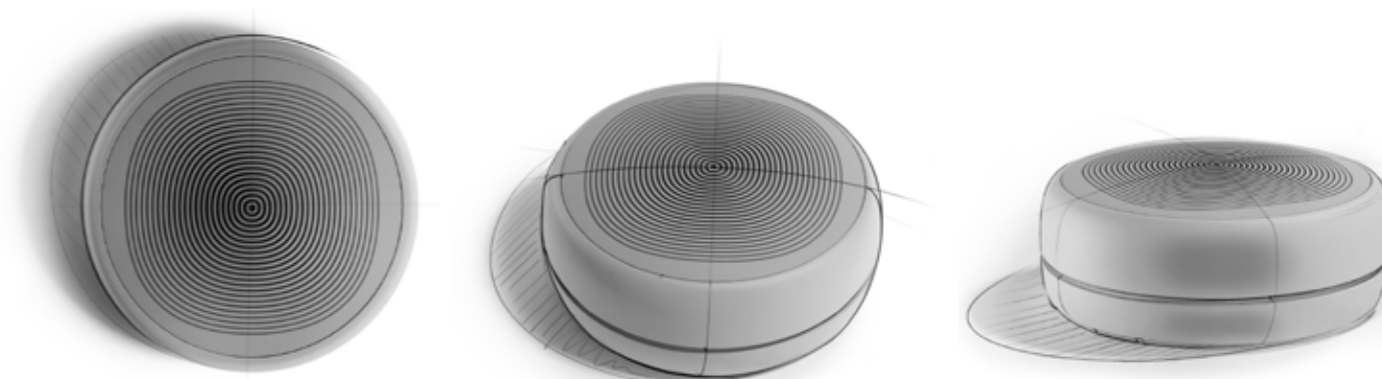
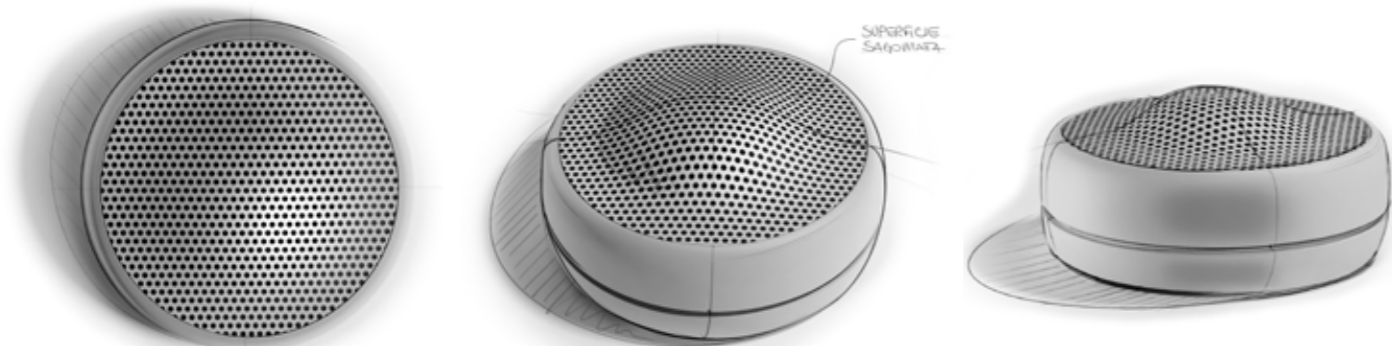

ACCESSORIO PLACCA

Asimmetria per uno stile originale.

La **PLACCA EYE BOX** in ABS con finitura estetica liscia e di colore bianco, completa la gamma ed è compatibile con qualsiasi fissaggio a parete. È un componente che si presta a molteplici personalizzazioni, dalla più semplice verniciatura in colore speciale, a finiture più complesse (cromatura / soft-touch) ed interventi sugli stampi ad iniezione plastica per ottenere una superficie materica. **Da impiegare con accessorio placca di fissaggio per scatole elettriche UK/USA/EUROPA, rispettivamente Ø 60, 3 posizioni e Ø 60 + 3 posizioni.**



PLAQUE ACCESSORY

Asymmetry for an original style.

EYE BOX PLAQUE in abs with a smooth white finish, completes the range and is compatible with any wall fixing. This component can be customised numerous ways, from simple painting in a special colour through to more complex finishes (chrome plating / soft-touch) and plastic injection moulding for a textured surface.

Assembly with wall mounting element for electrical box use UK/USA/EUROPE respectively Ø 60, 3 gang and Ø 60 + 3 gang.

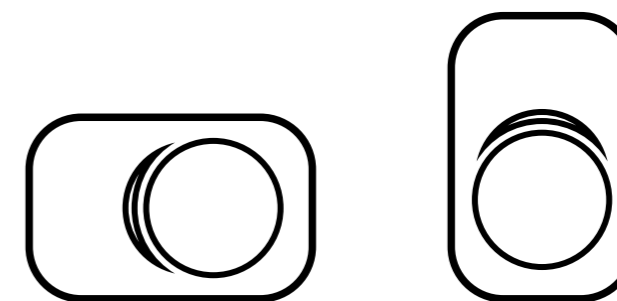

Attualmente per i mercati europei e UK è disponibile la versione orizzontale e per il mercato USA la versione verticale.

Currently the horizontal version is available for the UK and European markets, and the vertical version for the USA.



Possibili esempi di personalizzazioni superficiali da stampo
Possible examples of printed surface customisations.

SUPPORTI / SUPPORTS

Installazione senza limiti.

EYE BOX può diventare anche un contenitore da tavolo e disporre di supporti fissi o regolabili per parete o soffitto. L'azienda Italtronic per la versione da tavolo è impegnata nello sviluppo di alcune soluzioni esteticamente gradevoli e tecnologicamente competitive con connessioni a filo 220 volt o batteria.

Vi presentiamo alcuni esempi di possibili realizzazioni estetiche. Un punto di partenza per lo sviluppo di un oggetto dal design alternativo.

I prodotti non sono ancora disponibili ma sono solo una proposta estetica sulla quale, i nostri uffici tecnici, stanno già sviluppando i primi prototipi che potrebbero includere anche Vostre idee e richieste tecniche.

Limitless installations.

EYE BOX can become a table enclosure and have fixed or adjustable supports for wall or ceiling mounting. For the table version, Italtronic is committed to developing some highly attractive and technologically competitive solutions with 220V wire connections or batteries.

Here are some examples of different finishes. A starting point to develop something with an alternative design.

The products are not yet available, but it is a design that our technical offices are already developing the first prototypes for, which could also include your ideas and technical requests.

SUPPORTI DA TAVOLO AUTOALIMENTATI

SELF-POWERED TABLE SUPPORTS

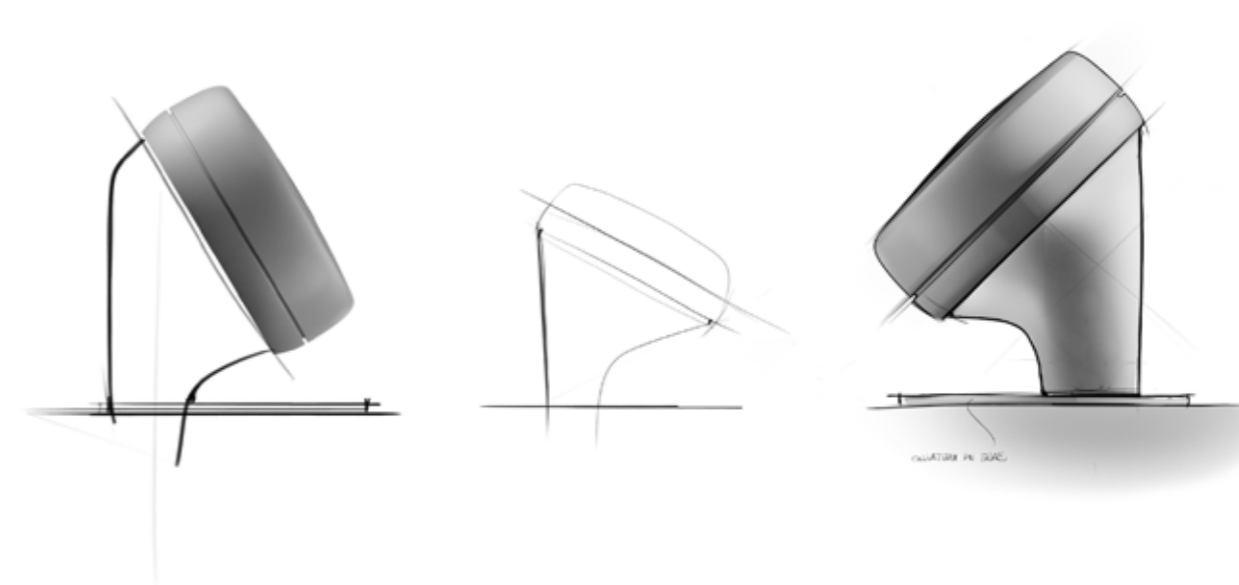
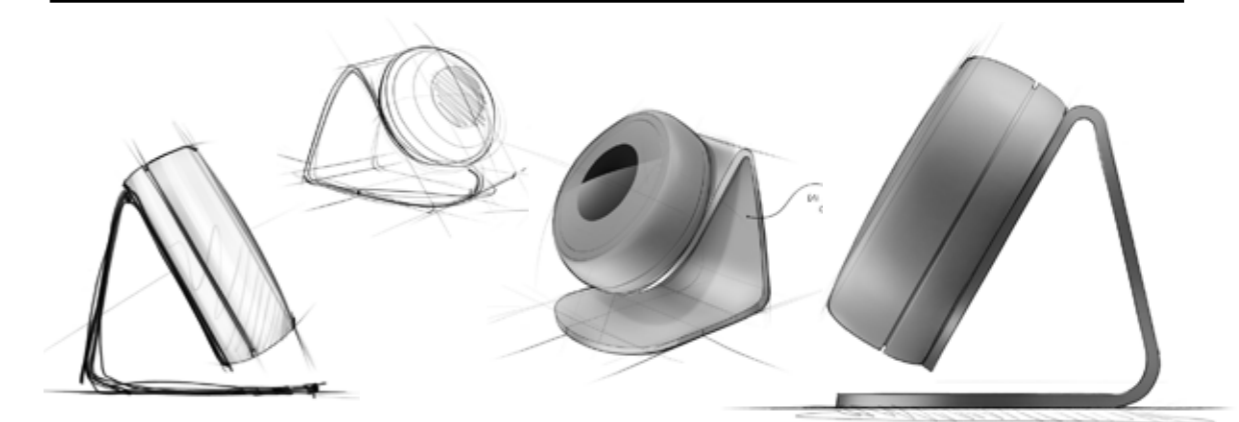
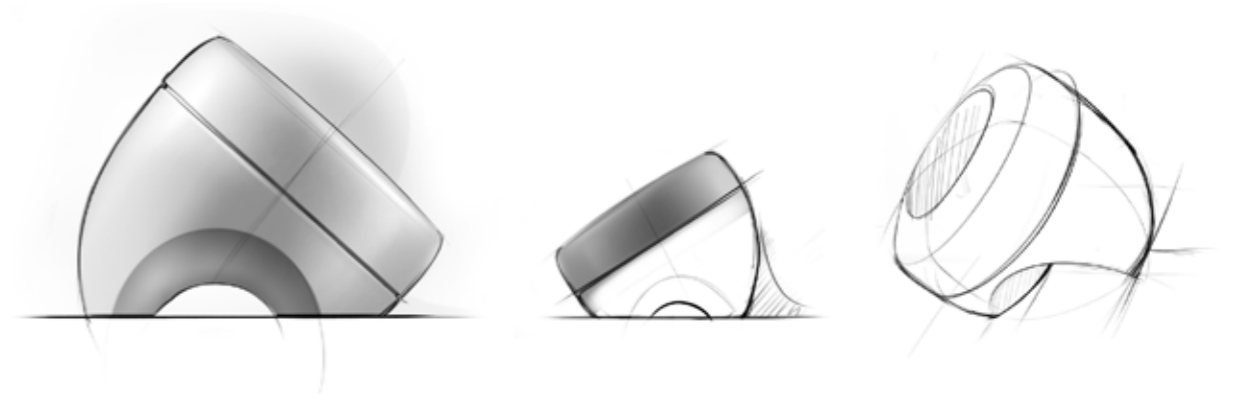
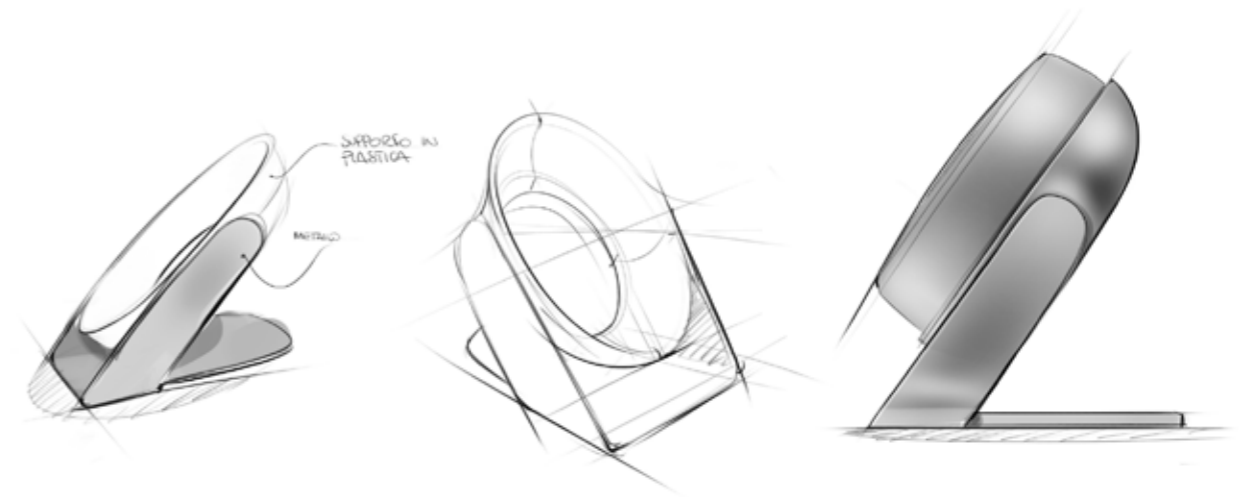
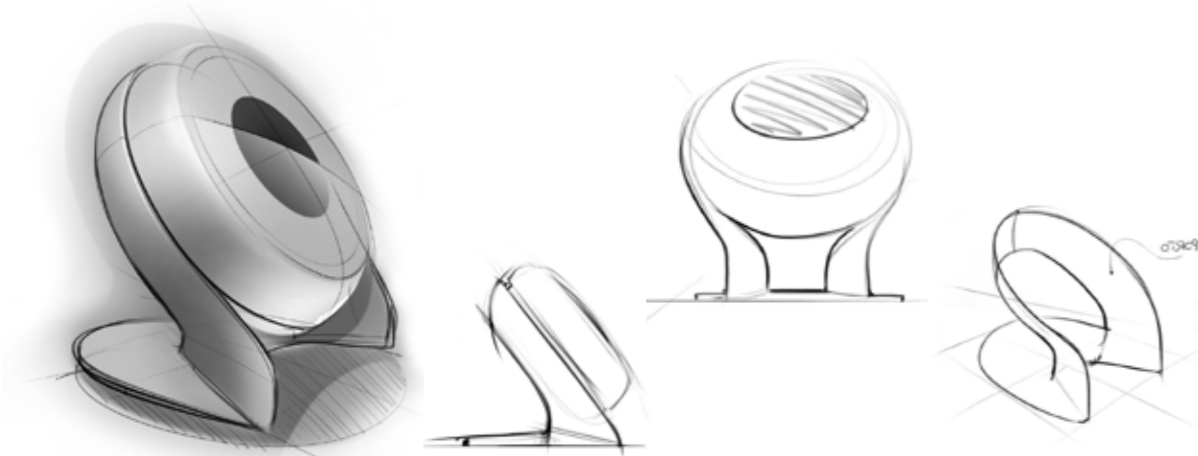

SUPPORTI DA TAVOLO ALIMENTATI POWERED TABLE SUPPORTS

SEZIONE
ELUTIKA

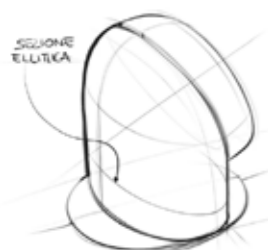

PIEDISTALLO PER EYEBOX CON CUSCINE IN TAVOLINO



IL PIEDISTALLO SOSTITUISCE
IL CUSCINO POSTERIORE DELL'EYEBOX
PER AVERE UNA MIGLIORE INTEGRAZIONE

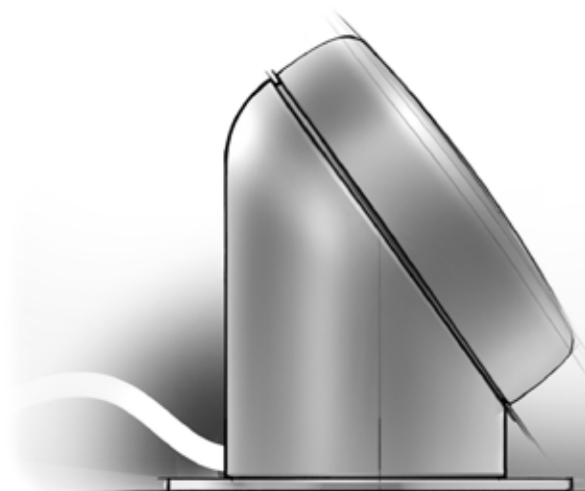
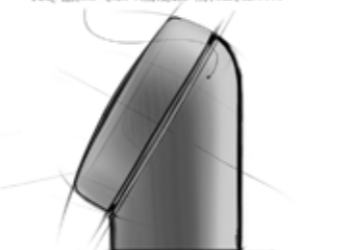

VISTA LATERALE

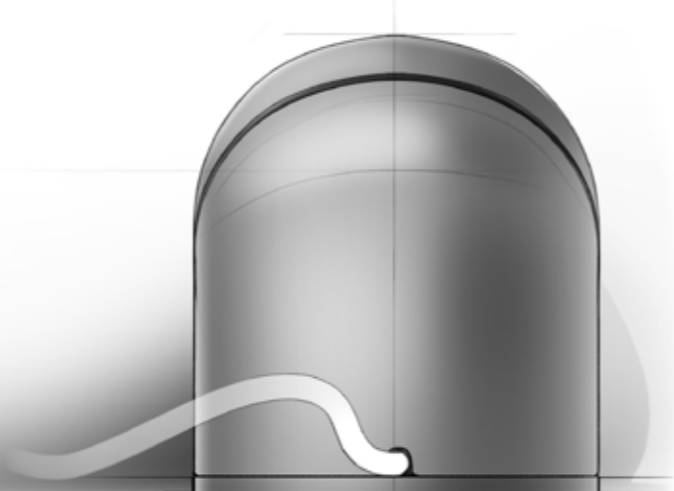

VISTA POSTERIORE

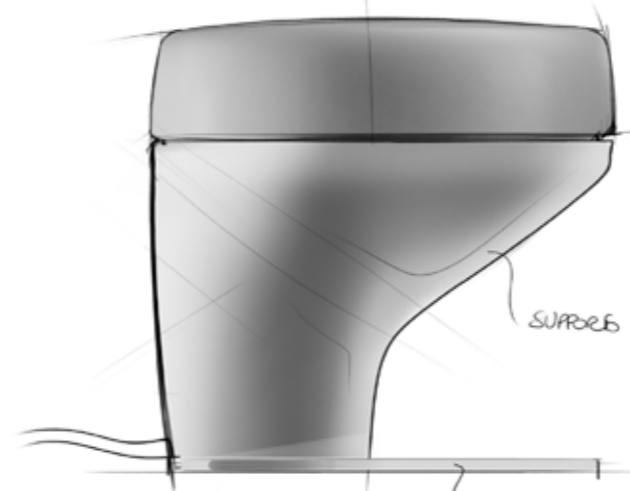
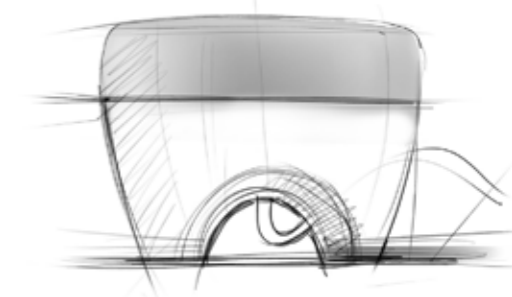
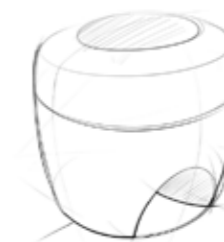

SUPP. 65

BASE IN
ALLUMINIO

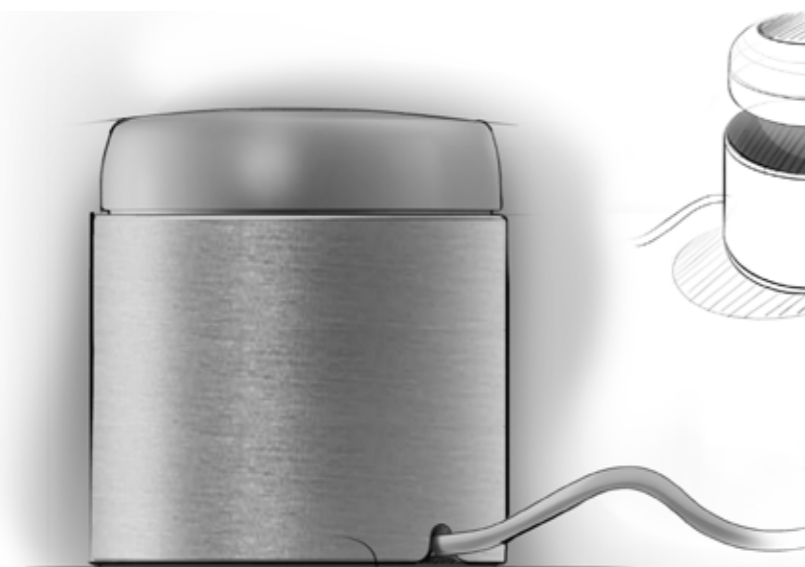

BASE TUBO ALLUMINIO

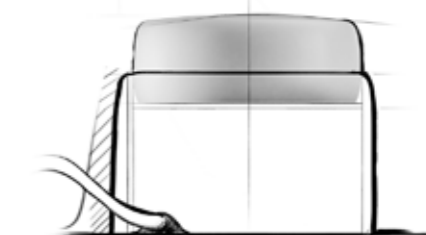
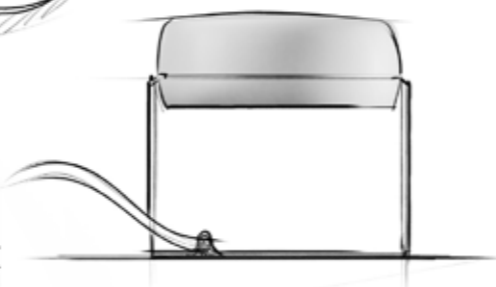

SUPPORTI FISSI / REGOLABILI A PARETE E SOFFITTO
FIXED/ADJUSTABLE SUPPORTS FOR WALLS AND CEILINGS

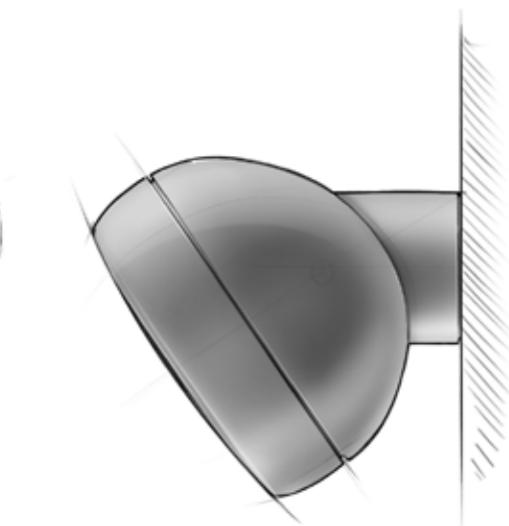
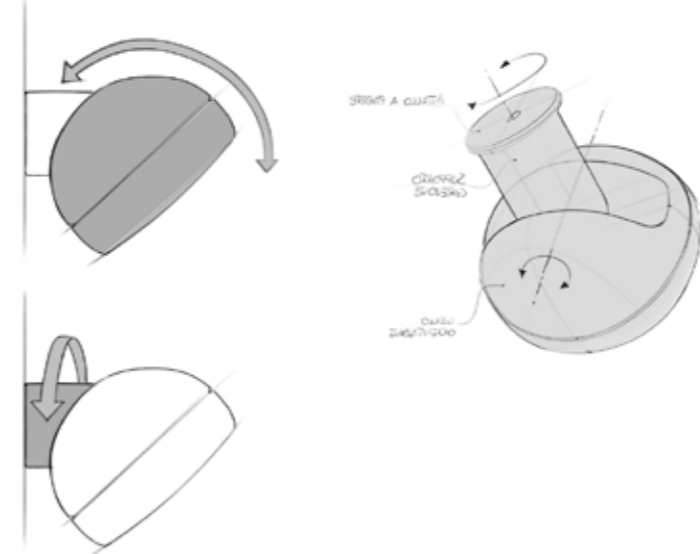
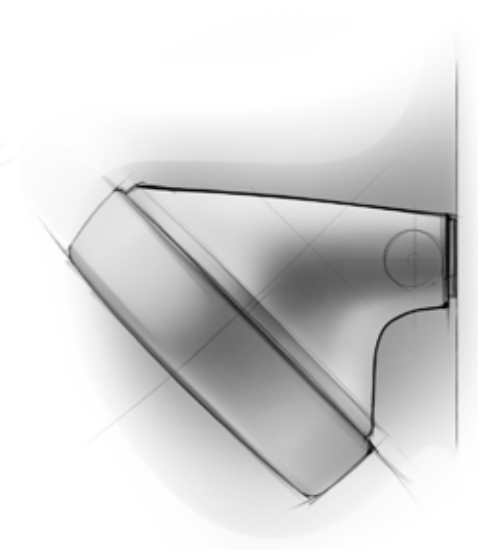
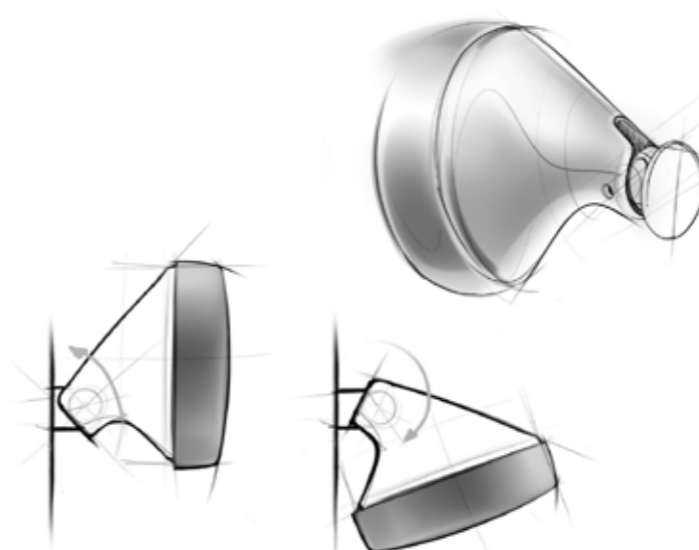
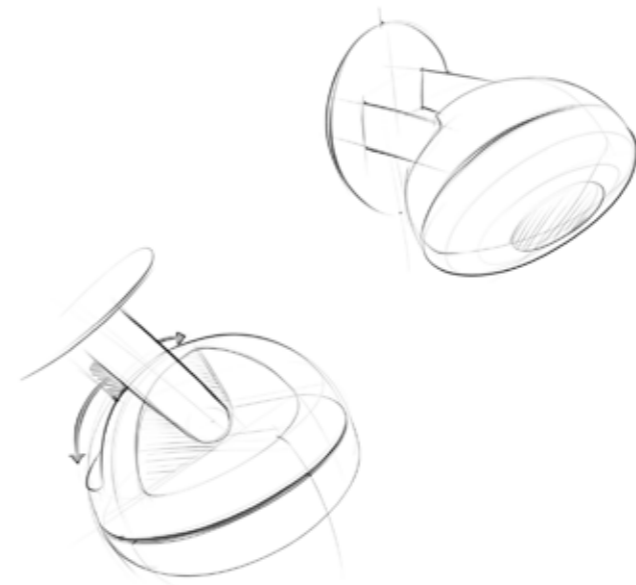
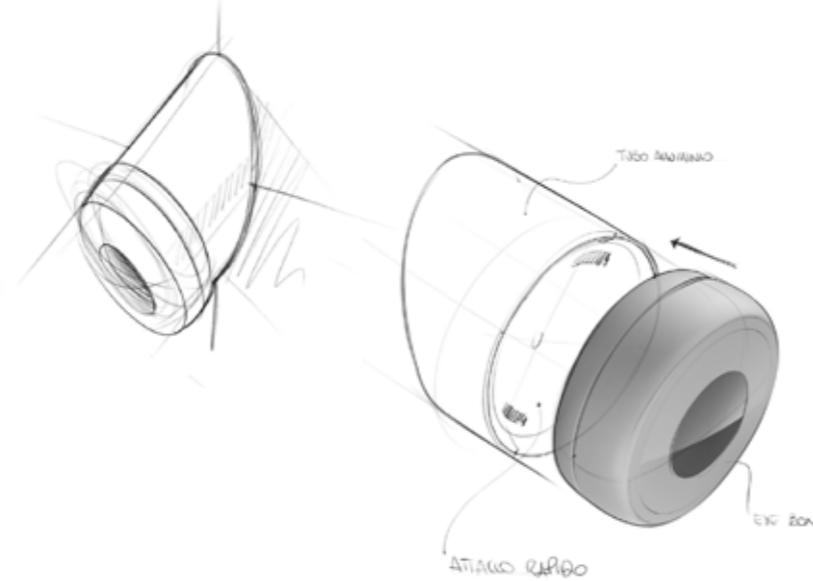
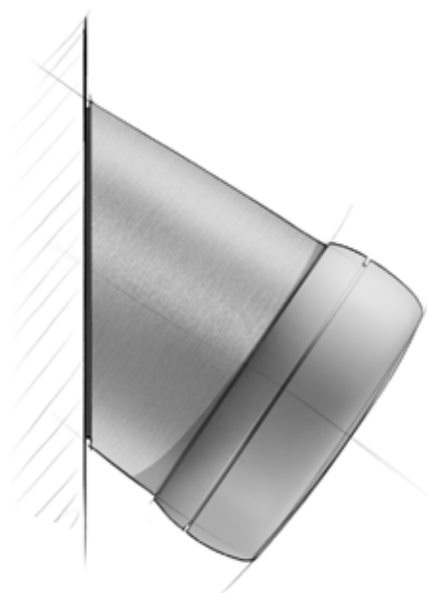
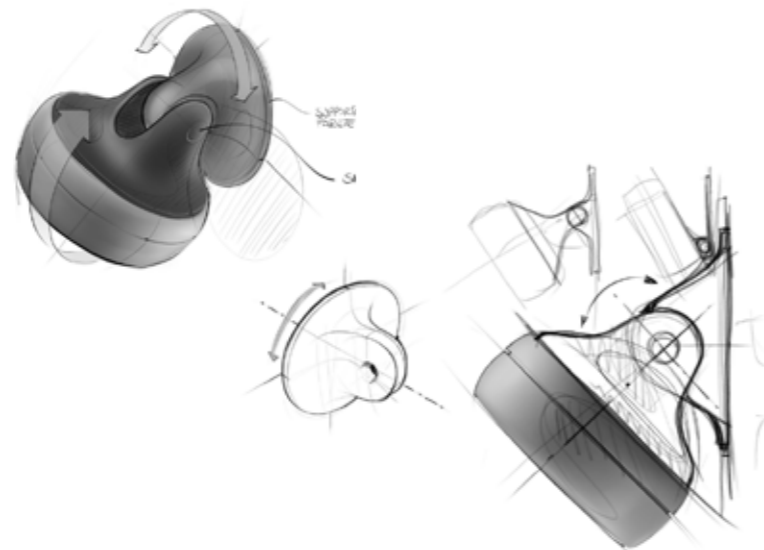
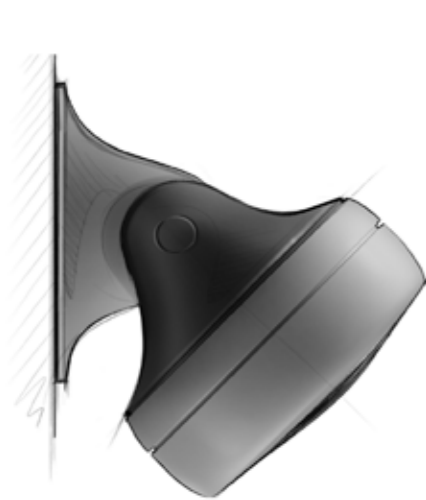
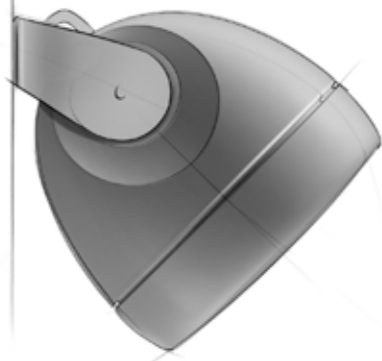

FINITURA ESTETICA GHIERA RING NUT FINISH

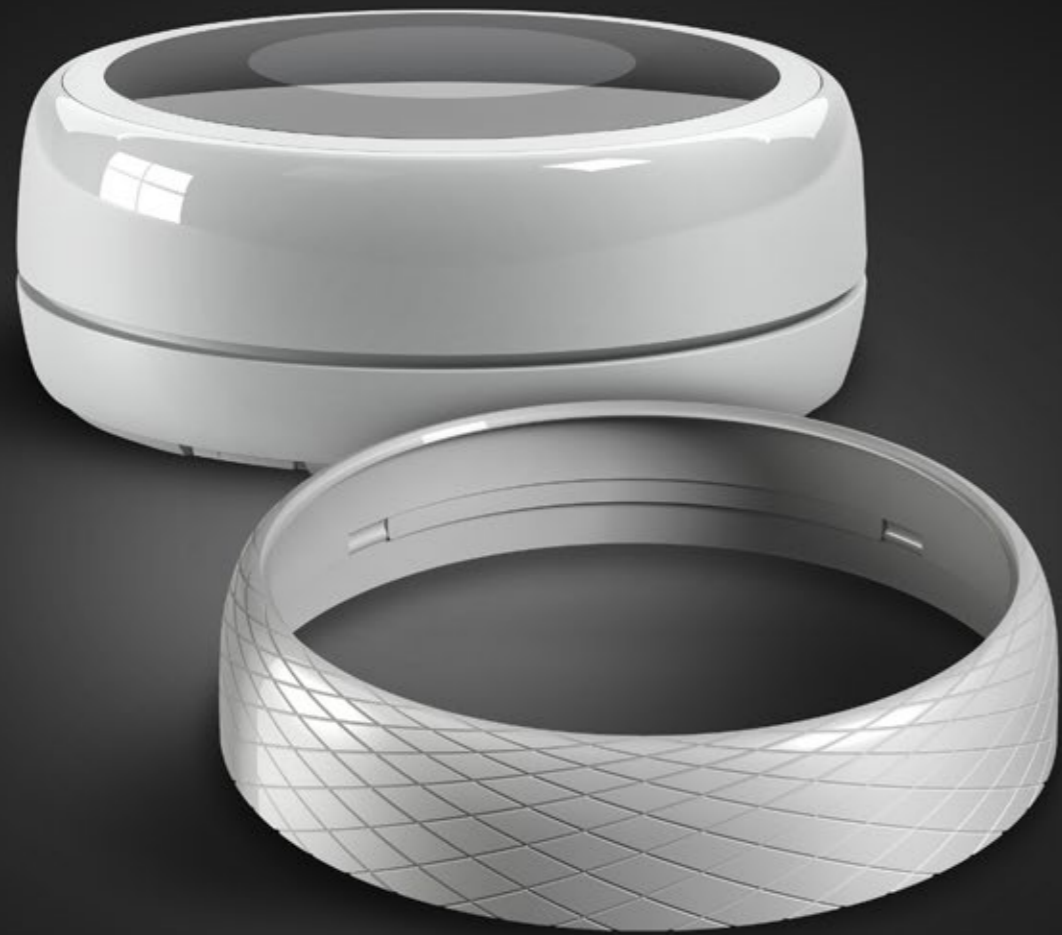

Bellezza a tutto tondo.

La linea di contenitori EYE BOX possiede una ghiera rotativa, cliccabile e personalizzabile in molteplici colori. La superficie inoltre, attraverso una modifica sullo stampo, può presentare una texture materica completamente personalizzabile. Sono disponibili anche finiture speciali, come il rivestimento in legno, la cromatura e la finitura soft touch. Questo dettaglio conferirà al vostro contenitore uno stile unico.

All round beauty.

The line of EYE BOX enclosures has a rotary, clickable and customizable ring nut in numerous colours. By simply changing the mould, the surface can be finished with a totally customizable texture. Special finishes are also available, such as wood coating, chrome plating and soft touch finish. This detail will give exclusive style to your enclosure.

Finiture superficie da stampo / Printed surface finish



Finiture superficiali texture / Textured surface finish



Legno - Wood / Cromatura - Chrome plating / Soft touch

COLORI / COLOURS

Spazio al colore per completare il tuo stile.

Ogni contenitore può essere personalizzato con infinite colorazioni. Il colore può essere conferito al contenitore per mezzo di una verniciatura RAL o attraverso la scelta del colore master della materia prima, che verrà impiegata direttamente per la produzione.

Space for colour to complete your style.

Each enclosure can be customised with an infinite range of colours. We can colour your enclosure using RAL paints or by choosing the master colour for the raw material that will be used directly in production.

FINITURE / FINISHES

Verniciatura RAL / RAL painting

La plastica della linea di contenitori EYE BOX può essere verniciata con un colore RAL di vostra scelta. La verniciatura avviene internamente con standard qualitativamente elevati.

The EYE BOX plastic enclosure can be painted with a RAL colour of your choice. Painting is done internally by our company to the highest standards.

Stampa da master / Master mould

È possibile realizzare il contenitore direttamente selezionando la matrice plastica colorata. Potrete così disporre di una personalizzazione sull'intera fornitura e rendere il vostro prodotto esclusivo e singolare.

The enclosure can be made by choosing a coloured plastic matrix. This will enable customizing your entire supply and make your product unique.



infinite colours

Potrete trovare tutti i dettagli accedendo al
CONFIGURATORE EYEBOX

You can find all the details by entering the
EYE BOX CONFIGURATOR



italtronic
enclosures for electronic

Italtronic Srl

Via Corso Stati Uniti, 17 - 35127 - Padova - Italy - T. +39 049 8947150 - F. +39 049 8947151 - www.italtronic.com